

Submersible Waste Water Pump

Ama-Drainer N 301/302/303/358

Type Series Booklet



Legal information/Copyright

Type Series Booklet Ama-Drainer N 301/302/303/358

All rights reserved. The contents provided herein must neither be distributed, copied, reproduced, edited or processed for any other purpose, nor otherwise transmitted, published or made available to a third party without the manufacturer's express written consent.

Subject to technical modification without prior notice.

© KSB SE & Co. KGaA, Frankenthal 18/12/2018

Contents

Building Services: Drainage	4
Drainage Pumps / Waste Water Pumps	4
Ama-Drainer N 301/302/303/358	4
Main applications.....	4
Fluids handled	4
Operating data.....	4
Design details	4
Designation	5
Materials.....	5
Product benefits.....	5
Certification.....	5
Overview of product features / selection tables	6
Technical data	7
Characteristic curves.....	8
Dimensions and connections	10
Accessories.....	13
Exploded view and list of components.....	20

Building Services: Drainage

Drainage Pumps / Waste Water Pumps

Ama-Drainer N 301/302/303/358



Main applications

- Drainage
- Disposal
- Drainage systems
- Lowering groundwater levels
- Maintaining groundwater levels
- Draining of pits, shafts, etc.

Fluids handled

Variant A (standard design)

- Slightly contaminated waste water (up to 50 °C max.)
- Wash water (up to 90 °C max. for short periods $t \leq 3$ minutes)
- Solid particles with a particle size of up to 10 mm (301, 302, 303)
- Solid particles with a particle size of up to 35 mm (358)
- Waste water without faeces
- Grey water
- River water, lake water and groundwater

Variant C (for aggressive water)

- Seawater
- Brackish water
- Water containing salt

Operating data

Operating properties

Characteristic		Value
Flow rate	Q [m ³ /h]	≤ 16,5
	Q [l/s]	≤ 4,6
Head	H [m]	≤ 12
Fluid temperature	T [°C]	≤ +50 (continuous duty)
		≤ +90 (short-time duty)

Design details

Design

- Fully floodable submersible motor pump
- Close-coupled design
- Single-stage
- Integrated swing check valve (301, 302, 303)
- Pump controlled via integrated float switch
- Enclosure IP68 (permanently submerged) to EN 60529 / IEC 529
- Wetted parts made of materials coated with anti-corrosive
- Maximum immersion depth: 2 m

Installation

- Vertical installation
- Wet-installed transportable model

Drive

- Jacket-cooled single-phase AC motor
- Integrated temperature switch
- Cable and shockproof plug

Shaft seal

- Drive end: 1 shaft seal ring
- Pump end, 2 shaft seal rings
- Liquid reservoir between the seals for cooling and lubrication

Bearings

- Enclosed bearings, grease-packed for life

Designation

Example: Ama-Drainer N 301 S E / C

Designation key

Code	Description	
Ama-Drainer N	Type series	
301	Code number 301, 302, 303, 358	
S	Float switch	
	S	With float switch
	N	Without float switch
E	Motor	
	E	Single-phase alternating current
C	Material	
	C ¹⁾	Variant for aggressive water
	- ²⁾	Variant for waste water

Materials

Overview of available materials

Component	Variant A		Variant C
	N 301/302/303	N 358	N 301/302/303
Pump casing	Polypropylene, 30 % glass fibre reinforced		
Discharge casing	Polypropylene, 30 % glass fibre reinforced		
Casing cover	Polypropylene with 20 % talc (PP-TS 20)		
Impeller	Noryl GNF2	Polyamide	Noryl GNF2
Motor housing	Chrome nickel steel (1.4301)	Chrome nickel steel (1.4301)	Chrome nickel molybdenum steel (1.4571)
Shaft	1.4057	1.4057	Chrome nickel molybdenum steel (1.4571)
Float switch (float)	Polypropylene		

Product benefits

- Ready-to-connect, easy installation and commissioning
- Maintenance-free with grease-packed bearings sealed for life
- Low-weight, corrosion-resistant, impact-resistant, abrasion-resistant, noise-dampening high-quality plastic housing with robust handle

Certification

Overview

Label	Effective in:	Comment
	Europe	-

1) Ama-Drainer N 301/302/303 only
2) Blank = standard design

Overview of product features / selection tables
Overview of product features

Overview

Characteristic	Ama-Drainer N 301	Ama-Drainer N 302	Ama-Drainer N 303	Ama-Drainer N 358
Head	6,5 m max.	10 m max.	12,5 m max.	8,5 m max.
Flow rate	10 m ³ /h max.	12 m ³ /h max.	14 m ³ /h max.	16,5 m ³ /h max.
Immersion depth	2 m max.	2 m max.	2 m max.	2 m max.
Voltage / frequency	230 V / 50 Hz	230 V / 50 Hz	230 V / 50 Hz	230 V / 50 Hz
Starting current	4,1 A	9,5 A	11,5 A	9,5 A
Maximum temperature, continuous	0 to 50 °C	0 to 50 °C	0 to 50 °C	0 to 50 °C
Maximum temperature, temporary ³⁾	+90 °C	+90 °C	+90 °C	-
Particle size (maximum diameter)	10 mm	10 mm	10 mm	35 mm
Residual water level (type NE for manual operation)	15 mm min.	15 mm min.	15 mm min.	37 mm min.
Power input	430 W max.	750 W max.	1050 W max.	850 W max.
Enclosure	IP68	IP68	IP68	IP68
Power cable	H07RN8-F 3×1 ²	H07RN8-F 3×1 ²	H07RN8-F 3×1 ²	H07RN8-F 3×1 ²
	Type SE H05RN8-F 3×0,75 ²	H05RN8-F 3×0,75 ²	H05RN8-F 3×0,75 ²	-
Frequency of starts (starts/hour)	30 max.			

Overview of fluids handled

The table of fluids handled is a selection aid for different applications. It serves as guidance and is based on long-standing experience. The data are reference values and are not to be considered generally binding recommendations. They shall not be the basis for warranty claims. Please contact your nearest sales branch for in-depth advice.

Table of fluids handled

Fluids handled	Variant A	Variant C
	301/302/303/358	301/302/303
Antifrogen-water mixture	X	-
Cider	X	-
Beer	X	-
Spirits	X	-
Buttermilk	X	-
Calcium acetate	X	-
Calcium hydroxide	X	-
Deionised water	X	-
Peanut oil	X	-
Vinegar	-	X
Ethylene glycol	X	-
Liquid fertiliser	X	-
Antifreeze	X	-
Glycol	X	-
Glycerine	X	-
Grisiron	X	-
Uric acid	X	-
Potassium hydroxide	X	-
Calcium carbonate	X	-
Coconut oil	X	-
Evaporated milk	X	-
Lemonades	X	-
Corn oil	X	-
Milk	X	-

3) Only valid for variant A

Fluids handled	Variant A	Variant C
	301/302/303/358	301/302/303
Whey	X	-
Sodium carbonate	X	-
Sodium chloride up to 3 % concentration	-	X
Sodium hydrogen phosphate	X	-
Sodium nitrate	X	-
Sodium perborate	X	-
Sodium sulphate	X	-
Polyglycols	X	-
Rapeseed oil	X	-
Castor oil	X	-
Silicone oil	X	-
Silo leachate	-	X
Soy-bean oil	X	-
Edible vinegar	-	X
Edible oil	X	-
Trisodium phosphate	X	-
Vaseline	X	-
Washing machine lye	X	-
Water		
Drainage water	X	-
Fire-fighting water	X	-
Heating water	X	-
Lime water	-	X
Boiler water	X	-
Condensate	-	X
Cooling water	X	-
Seawater	-	X
Raw water	X	-
Swimming pool water (DIN 19 643)	-	X
Salt water	-	X
Partly desalinated water	X	-
Fully desalinated water	-	X

Technical data

Technical data for variant A

Size	Discharge-side connection	Maximum free passage	P ₁	P ₂	≈ I _n	Power cable H 07 RN-F.G.		Mat. No.	[kg]
		[mm]				[m]	[mm ²]		
301 SE	Rp 1 1/4	10	0,43	0,18	1,9	5 ⁴⁾	3 × 0.75 ⁵⁾	39300070	4,5
302 SE	Rp 1 1/4	10	0,75	0,36	4,0	5 ⁴⁾	3 × 0.75 ⁵⁾	39300074	6
303 SE	Rp 1 1/4	10	1,05	0,50	4,9	5 ⁴⁾	3 × 0.75 ⁵⁾	39300078	6,2
301 SE/NE ⁶⁾	Rp 1 1/4	10	0,43	0,18	1,9	10	3 × 1.0	39300072	5,2
302 SE/NE ⁶⁾	Rp 1 1/4	10	0,75	0,36	4,0	10	3 × 1.0	39300076	6,7
303 SE/NE ⁶⁾	Rp 1 1/4	10	1,05	0,50	4,9	10	3 × 1.0	39300081	6,9
358 SE/NE ⁶⁾	Rp 1 1/2	35	0,85	0,43	4,0	10	3 × 1.0	39300083	6,8

Technical data for variant C

Size	Discharge-side connection	Maximum free passage	P ₁	P ₂	≈ I _n	Power cable H 07 RN8-F.G.		Mat. No.	[kg]
		[mm]				[m]	[mm ²]		
301 SE/NE/C ⁶⁾	Rp 1 1/4	10	0,43	0,18	1,9	10	3 × 1.0	39300073	5,2
302 SE/NE/C ⁶⁾	Rp 1 1/4	10	0,75	0,36	4,0	10	3 × 1.0	39300077	6,7
303 SE/NE/C ⁶⁾	Rp 1 1/4	10	1,05	0,50	4,9	10	3 × 1.0	39300082	6,9

4) Submersible motor pump used outdoors must have a power cable at least 10 m in length according to EN 60 335-2-41.

5) Power cable H 05 RN8-F.G.

6) If the pump set is controlled by external input or used in dual-pump stations, the float switch must be replaced by the locking disc supplied.

Characteristic curves

Ama-Drainer N 301, 302, 303; n = 2800 rpm, multi-vane impeller

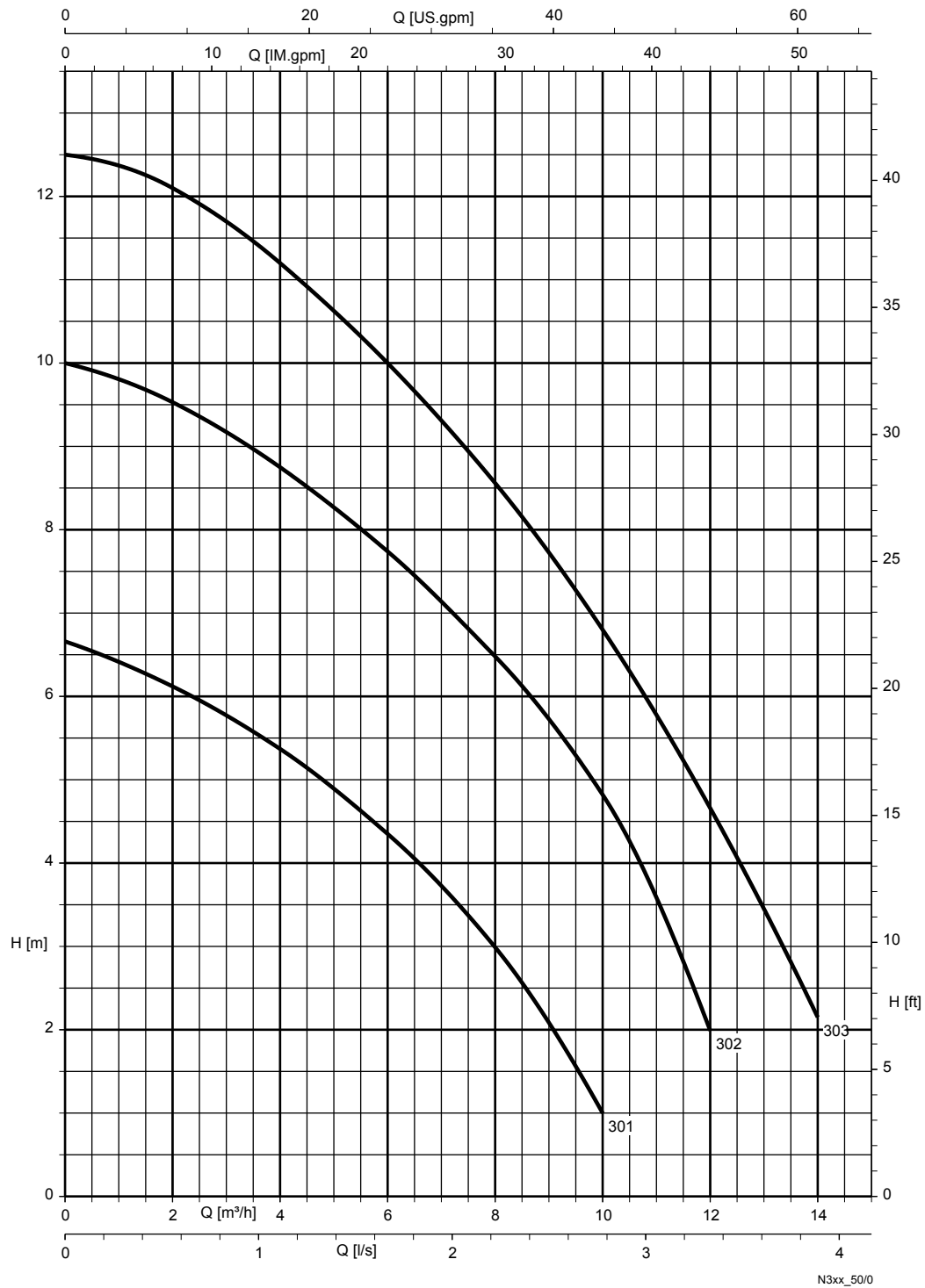

Fig. 1: Free passage: 301/302/303 = 10 mm
Performance tolerance to ISO 9906, Annex A (water under standard conditions)

Ama-Drainer N 358; n = 2800 rpm, F impeller

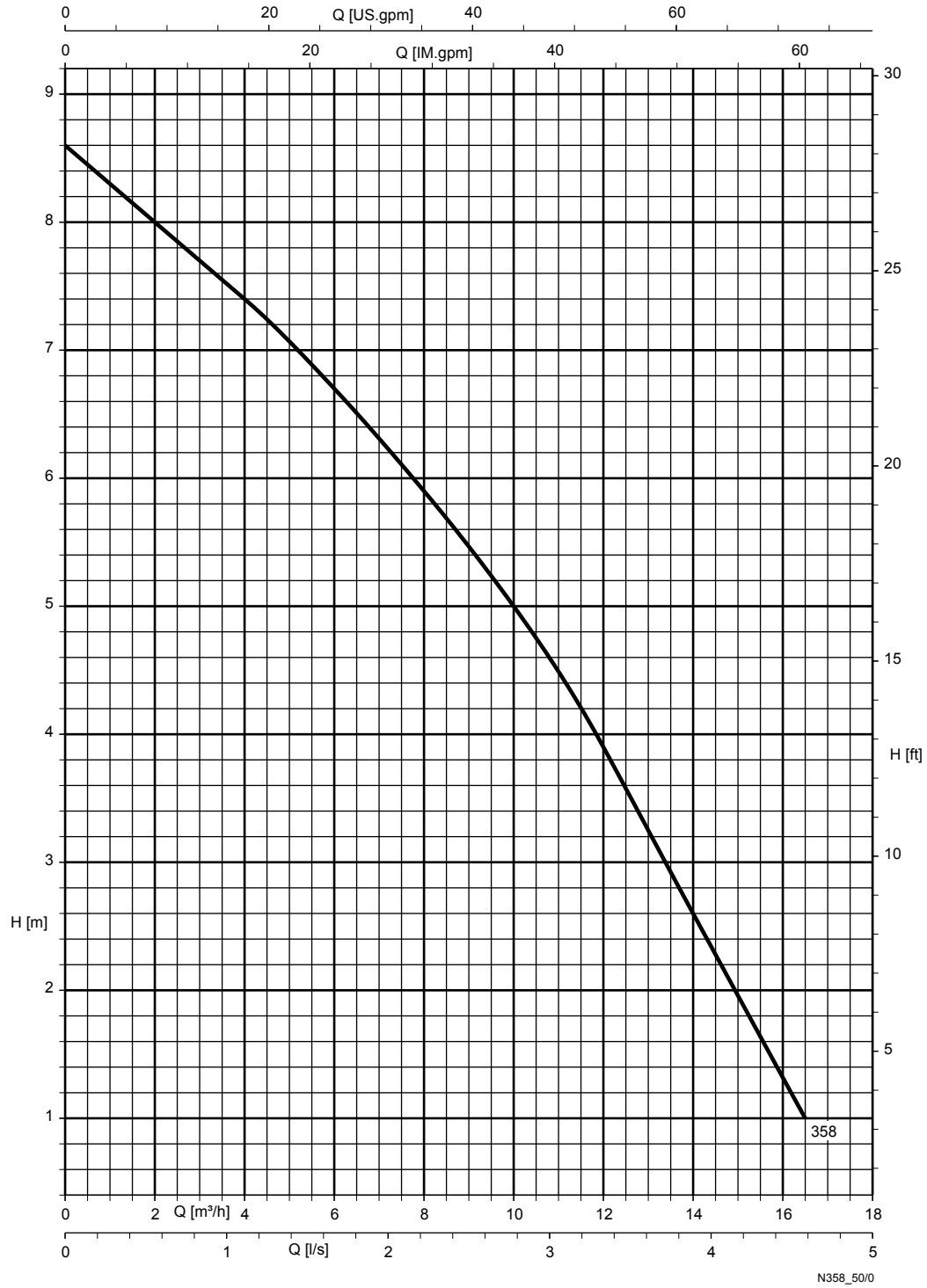

Fig. 2: Free passage: 358 = 35 mm
Performance tolerance to ISO 9906, Annex A (water under standard conditions)

Dimensions and connections

Ama-Drainer N 301, 302, 303, 358

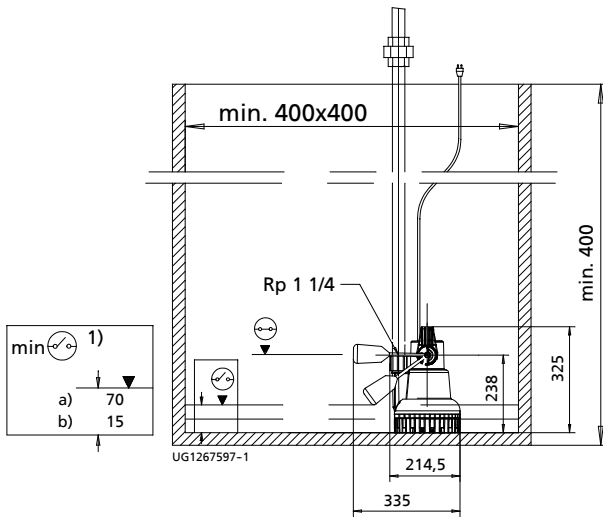

Fig. 3: Outline drawing of Ama-Drainer N 301 SE

1)	Residual water level
a)	Automatic
b)	Manual

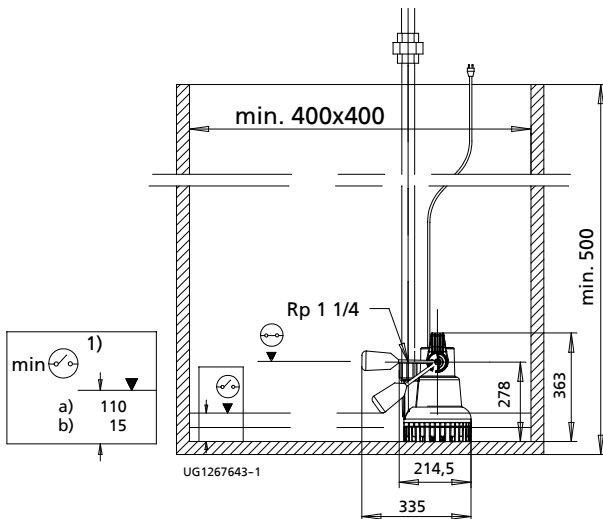

Fig. 4: Outline drawing of Ama-Drainer N 302 SE / 303 SE

1)	Residual water level
a)	Automatic
b)	Manual

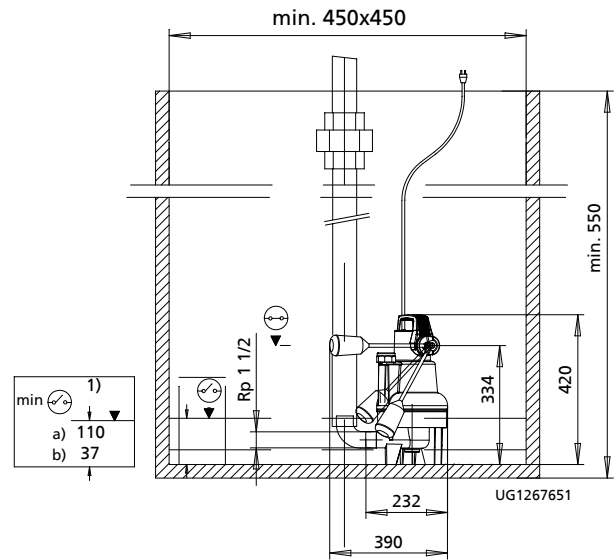

Fig. 5: Outline drawing of Ama-Drainer N 358

1)	Residual water level
a)	Automatic
b)	Manual

Installation example of a dual-pump station

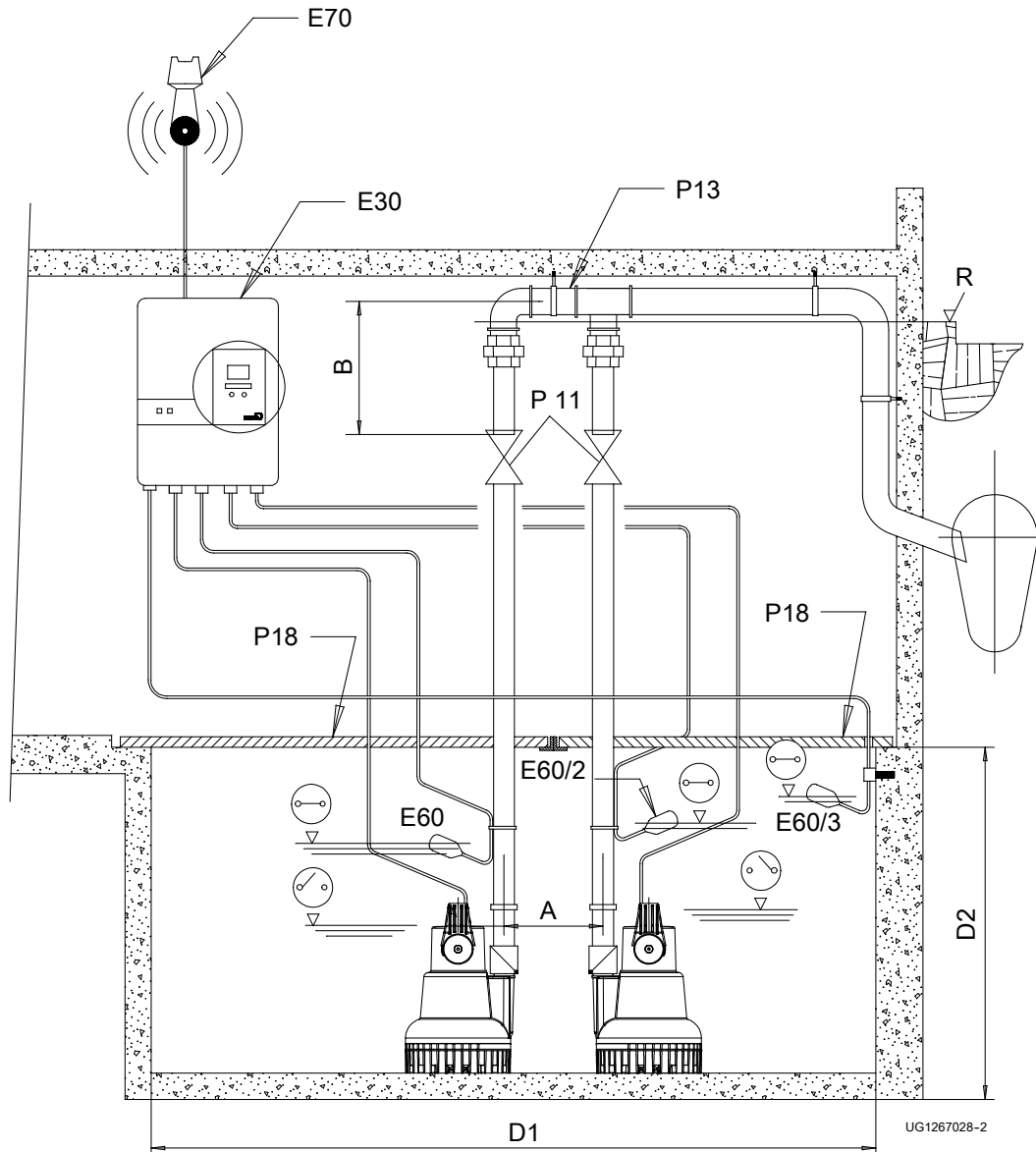

Fig. 6: Installation example of an Ama-Drainer N 301 NE / 302 NE / 303 NE dual-pump station

1)	Residual water level
a)	Automatic
b)	Manual
P10	Lift check valve (only 358)
P11	Gate valve
P13	Y-pipe
P18	Cover plate
E30	Control unit
E60	Float switch, base load
E60/2	Float switch, peak load
E60/3	Float switch, high water alert
E70	Horn
R	Flood level

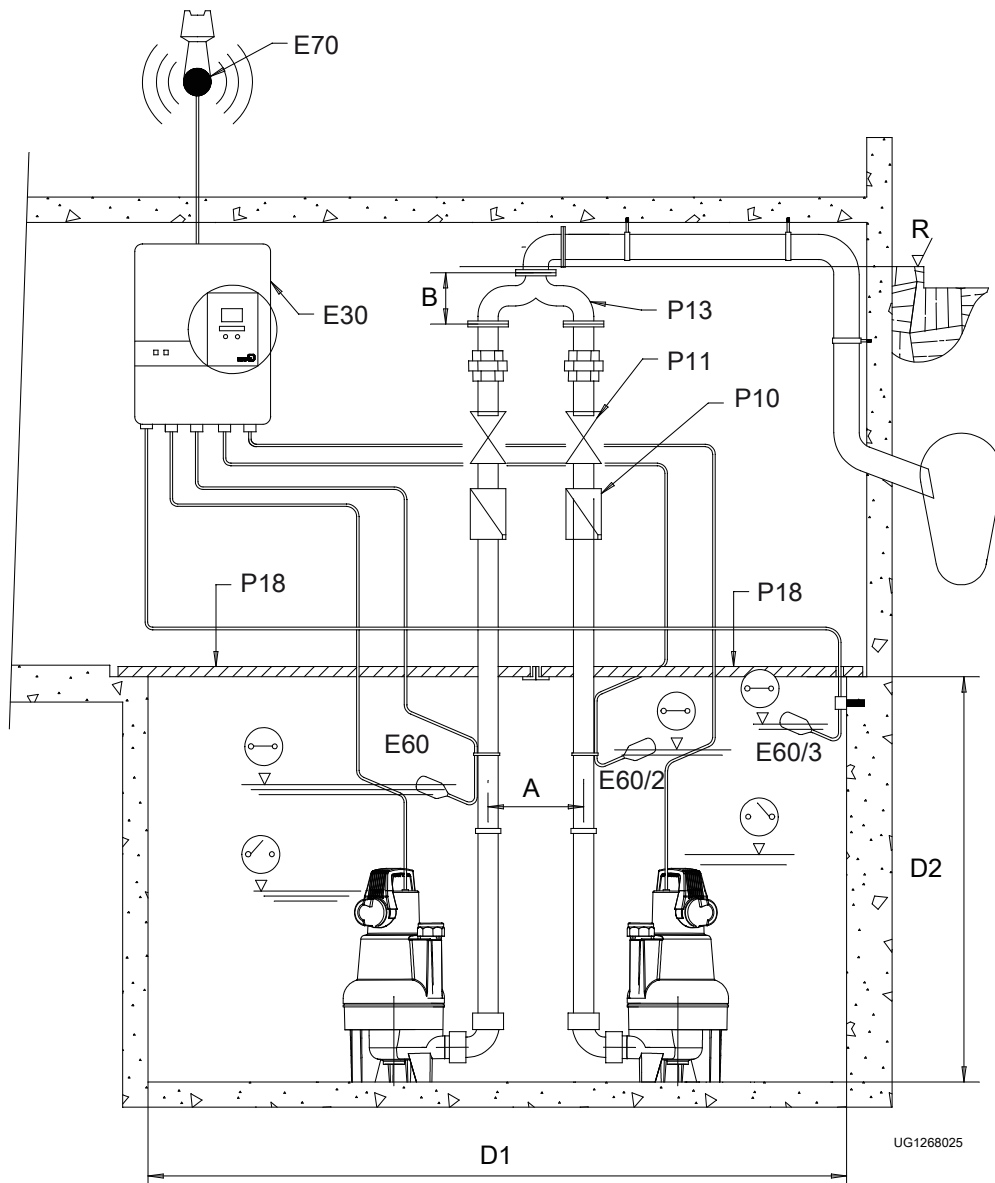















Fig. 7: Installation example of an Ama-Drainer N 358 NE dual-pump station

1)	Residual water level
a)	Automatic
b)	Manual
P10	Lift check valve (Ama-Drainer N 358 only)
P11	Gate valve
P13	Y-pipe
P18	Cover plate
E30	Control unit
E60	Float switch, base load
E60/2	Float switch, peak load
E60/3	Float switch, high water alert
E70	Horn
R	Flood level

Dimensions of a dual-pump station

Size	A	B	D1	D2
	[mm]	[mm]	[mm]	[mm]
301	275	320	1060 × 500	400
302	275	320	1060 × 500	500
303	275	320	1060 × 500	500
358	275	180	1060 × 500	550





Accessories
Pump accessories

Item	Description	Connection	Ama-Drainer N				Mat. No.	[kg]
			301	302	303	358		
P10 	RK swing check valve	Rp 1 1/4	X	X	X	-	01009771	0,1
	plastic, EN 12 050-4, with internal thread ISO 7/1, with full port and drain plug	Rp 1 1/2	-	-	-	X	01009772	0,25
P10 	Lift check valve, stainless steel (1.4401)	Rp 1 1/4	X	X	X	-	01084936	2,1
		Rp 1 1/2	-	-	-	X	01084935	2,2
P11 	Socket gate valve Material: CuZn PN 16, with internal thread, with full port	Rp 1 1/4	X	X	X	-	01014219	0,627
		Rp 1 1/2	-	-	-	X	00411502	0,8
P13 	Y-pipe for dual-pump sets, with external thread, galvanised steel	Rp 1 1/4	X	X	X	-	18040311	4,1
P13 	Y-pipe for dual-pump sets, grey cast iron, with hexagon head bolts, nuts and gaskets; flanges drilled to DIN 2501	DN 40	-	-	-	X	40000688	10,6
P18 	Cover plate Tread-proof, split, with profile seals and angle iron mounting frame (type A 560) for 500 x 500 mm pits (Dual-pump sets with P13 Y-pipe are equipped with 2 cover plates next to each other.)	Rp 1 1/4	X	X	X	X	18075627	13
P21 	A 25 B drain hose set (see P32) Comprising: rigid coupling with external thread, 6 m plastic hose DN 25, rapid-action hose coupling Rp 1 1/4, (free passage 21 mm)	Rp 1 1/4	X	X	X	-	18079719	3
P21 	Drain hose set Comprising: plastic hose, DN 40 or DN 50 (with integrated C couplings, DIN14811) and Storz rigid coupling (with internal thread to ISO 228/1) Can be selected via P24 and P28	C 42	-	-	-	X	-	-
P24 	Storz rigid coupling with internal thread to DIN ISO 228/1 Aluminium alloy, for required piping components see P32	C-G 1 1/2	X	X	X	X	01002463	0,3
P26 	Storz hose coupling, aluminium alloy Required counterpart see P24	C 52 (DIN 14321)	X	X	X	-	00524551	0,3
P28 	Plastic hose DN 40, with integrated C couplings, DIN 14811 Plastic hose DN 50, DIN 14811, with integrated C couplings Required piping components see P32	C 42-5 m	X	X	X	X	01062592	1,7
		C 42-10 m	X	X	X	X	01062593	2,8
		C 42-20 m	X	X	X	X	01062594	5
		C 52	X	X	X	X	00522262	2,3
		C 52	X	X	X	X	00522263	4,2
P29 	Threaded flange for Y-pipe (P13), internal thread	C 52	X	X	X	X	00522264	5,7
		DN 40/Rp 1 1/2	-	-	-	X	00260478	1,8
P31 	Bellmouth for draining residual water		X	X	X	-	39300101	0,2
P32 	Pipe extension for Storz rigid coupling C (P24) PVC hard, internal/external thread For use without swing check valve and union nut	IG Rp 1 1/4 / AG R 1 1/2 x 170	X	X	X	-	11035587	0,2

Switchgear

 Not valid for France.

Overview of control units and switchgear

Item	Description	230 V	Type	Ama-Drainer N				Mat. No.	[kg]
				1~					
				301	302	303	358		
E1 	MSE motor protection switchgear	X	25.1	X	-	-	-	19070136	1
	Float switch	X	60.1	-	X	X	X	19070138	1
E10 	LevelControl Basic 2 control unit for single-pump station, IP54 DOL starting, with manual-0-automatic selector switch, indicator lamps and control panel, high water alert, integrated alarm buzzer 85 dB(A), operating hours counter/start-stop cycles per pump, voltage measurement, phase monitoring, indication of water level, volt-free contact for general fault message, motor temperature warning (thermal circuit breaker) – self-acknowledging; motor leakage/moisture monitoring, optional mains-independent alarm via rechargeable battery (E90) For float switch or 4 - 20 mA sensor, optionally with master switch, 400 x 281 x 135 mm	X	BC1 230 ^{DFNO} 100	X	X	X	X	19073760	4,5
E30 	LevelControl Basic 2 control unit for dual-pump station, IP54 Peak load operation function, stand-by pump, DOL starting, with manual-0-automatic selector switch, indicator lamps and control panel, high water alert, integrated alarm buzzer 85 dB(A), operating hours counter/start-stop cycles per pump, pneumatic: indication of water level, voltage measurement, phase monitoring, volt-free contact for general fault message, 230 V variant: with external socket, 400 V variant: with motor protection switch, mains-independent alarm via rechargeable battery optional For float switch or 4...20 mA sensor, optional master switch, 400 x 281 x 135 mm	X	BC2 230 ^{DFNO} 100	X	X	X	X	19073774	4,7
Optional components for LevelControl⁷⁾									
O1 	Master switch for LevelControl Basic 2 BC, fitted	-	-	X	X	X	X	01143084	0,2
O200 	Signalling module for type BC	-	-	X	X	X	X	19075182	0,2

7) Process optional components via KSB EasySelect, otherwise they might be supplied but not fitted.

Operation with mini control system

For Ama-Drainer N 301 SE/NE, 302 SE/NE and 303 SE/NE with 10 m power cable use the locking disc supplied. Separate float switches are required for operation with mini control systems.

LevelControl with float switch(es)

Single pump:

- At least 1 float switch for pump On/Off
- At least 2 float switches for pump On/Off and high water alert

Dual pump:

- At least 2 float switch for pump On/Off
- At least 3 float switches for pump On/Off and high water alert

Twin operation with two level switches at different levels

If two pumps are used in the same location, we recommend operating them via the LevelControl unit. This enables automatic alternating, peak load and stand-by operation. External alarm switchgear will not be required as LevelControl features an integrated alarm function.

Connection to the control station

With the exception of MSE, each control unit features a volt-free contact for transmitting the general fault message to a control station.

LevelControl Basic 2 control units

 Not valid for France.

Key to the symbols

Symbol	Description
o	Optional
X	Available
-	Not available





Overview of LevelControl Basic 2 control units

Feature	Single-pump station float switch or 4 - 20 mA sensor	Dual-pump station float switch or 4 - 20 mA sensor
230 V, up to 10.0 A	BC1 230 ^{DFNO} 100	BC2 230 ^{DFNO} 100
Functions		
Draining	X	X
Filling via float switch(es)	X	X
Stand-by pump: 1 pump redundant	-	X
Pump changeover after each start	-	X
Pump changeover in the case of a pump fault	-	X
Peak load operation function	-	X
Runtime limitation	X	X
OFF via after-run time	X	X
OFF via level	X	X
Functional check run after idle period	X	X
Alert history	X	X
Display and operation		
7-segment display	X	X
Indication of water level	Switching points	Switching points
Operation/fault/pump running (displayed for each pump)	Multicolour LED	Multicolour LED
General fault (traffic light)	LED	LED
High water	LED	LED
Mains voltage	X	X
Mains frequency	-	-
Motor current per pump	-	-
Operating hours of each pump	X	X
Operating hours of the system	-	-
Starts per pump	X	X
Effective power per pump	-	-
Phase monitoring	X	X
Change of switching level via control panel	X	X
Housing H x W x D [mm], IP54		
Plastic 400 x 281 x 135	X	X
Sheet steel 400 x 300 x 155	-	-
Sheet steel 600 x 400 x 200	-	-
Built-in components		
Master switch (lockable)	o	o
Manual-0-automatic selector switch per pump	X	X
DOL starting	X	X
Star-delta starting	-	-
Shockproof socket 230 V	X	X
Motor protection		
Fuse per pump	X	X
Motor protection switch per pump (overcurrent protection and short-circuit protection)	-	-
Motor temperature warning input	X	X
Motor temperature alert input	X	X
Pump		
Thermal circuit breaker (TCB) / bimetal switch per pump	Bimetal switch in the motor	Bimetal switch in the motor
Optional components		









Feature	Single-pump station float switch or 4 - 20 mA sensor	Dual-pump station float switch or 4 - 20 mA sensor
Rechargeable battery for powering the device	o	o
Alarm equipment		
1 free alarm input	x	x
1 digital input for high water alert	x	x
Volt-free contact (changeover contact) for general fault message / "in operation" message	x	x
Piezo buzzer 85 dB(A)	x	x
Horn / alarm combination / alarm strobe light 12 V DC	o	o
Inputs/outputs		
Inputs for float switches	4	4
4 - 20 mA analog input	x	x
Integrated pneumatic pressure sensor up to 3 metres of water (up to 10 metres on request)	-	-
Bubbler control with compressor up to 2 metres of water	-	-
Remote acknowledgement	x	x
12 V DC connection for horn, etc.	x	x
Sensors		
Float switch (NO contact)	o	o
F1 leakage sensor	o	o
Tools		
KSB Service Tool for Windows XP	o	o

Alarm switchgears for pumps, non-ATEX-compliant

AS 0/AS 1/AS 2/AS 4/AS 5

Item	Description	Mat. No.	[kg]
E50	 <p>Alarm switchgear AS 0</p> <p>with circuit breaker, acoustic signal transmitter with 85 dB(A), green equipment-on lamp</p> <p>Plastic housing, IP20, H x W x D = 140 x 80 x 57 [mm]. Use float switch, F1 leakage sensor (item E64), M1 alarm contactor or signal relay of control unit as contactor.</p>	29128401	0,5
E51	 <p>Alarm switchgear AS 2</p> <p>With circuit breaker, acoustic signal transmitter with 85 dB(A), green equipment-on lamp, volt-free contact for hook-up to a control station</p> <p>Plastic housing, IP20, H x W x D = 140 x 80 x 57 [mm]. Use float switch, F1 leakage sensor (item E64) or signal relay of control unit as contactor.</p>	29128422	0,5
E52	 <p>Alarm switchgear AS 4</p> <p>With circuit breaker, acoustic signal transmitter with 85 dB(A), green equipment-on lamp, volt-free contact for hook-up to a control station, self-charging power supply unit for 5 hours of operation in the event of a power failure</p> <p>Plastic housing, IP20, H x W x D = 140 x 80 x 57 [mm]. Use float switch (E60), F1 leakage sensor (item E64) or signal relay of control unit as contactor.</p>	29128442	0,5
E53	 <p>Alarm switchgear AS 5</p> <p>Mains-independent, with self-charging power supply unit for 10 hours of operation in the event of a power failure, mains pilot LED, fault indicator light, horn-off pushbutton, volt-free contact for hook-up to a control station, ready for connection with 1.8 m connection cable and plug.</p> <p>ISO housing, IP41, H x W x D = 190 x 165 x 75 [mm]. Use float switch (E60) or signal relay of control unit as contactor.</p>	00530561	1,7
E55	 <p>Alarm switchgear AS 1</p> <p>In IP30 ISO plug housing, mains-independent, with self-charging power supply unit for 5 hours of operation in the event of a power failure, acoustic signal transmitter 70 dB(A) with circuit breaker and integrated signal transmitter with 3-metre connection cable, max. 60 °C, not suitable for steam and condensate.</p> <ol style="list-style-type: none"> High water alert by suspending the sensor in a (pump) sump above the pump start-up point. Water alarm signal at a water level of only 1 mm (!), by placing the sensor on the floor in areas with a flooding or leakage risk, e.g. the cellar or next to the washing machine in the kitchen or bathroom. 	00533740	0,9

Accessories for control units/switchgears

Item	Description	Length of cable / hose [m]	Ama-Drainer N				Mat. No.	[kg]
			1~					
			301	302	303	358		
 E60 Float switch with free cable end Switch housing made of polypropylene (fluid temperature 70 °C max.) 230 V AC or 24 V AC/DC, 8 A max., 20 mA min. Function: circuit closed in upper float position (NO contact) Power cable: H07RN-F3G1	3	X	X	X	X	11037742	0,5	
	5	X	X	X	X	11037743	0,8	
	10	X	X	X	X	11037744	1,3	
	15	X	X	X	X	11037745	1,8	
	20	X	X	X	X	11037746	2,4	
	25	X	X	X	X	11037747	2,9	
	30	X	X	X	X	11037748	3,4	
 E60.1 Float switch for draining, with shockproof plug (NO contact) Switch housing made of polypropylene (fluid temperature 70 °C max.) 230 V AC, max. 8 A Function: circuit closed in upper float position Power cable: H07RN-F3G1, not suitable for drinking water applications	3	X	X	X	X	11037749	1,1	
	5	X	X	X	X	11037750	1,3	
	10	X	X	X	X	11037751	1,6	
 E61 Float switch with free cable end, oil-resistant Function: circuit closed in upper float position (NO contact) Power cable: PUR 3×1.0 mm ²	5	X	X	X	X	11037753	0,8	
	10	X	X	X	X	11037754	1,2	
	20	X	X	X	X	11037755	2	
 E62 Float switch with free cable end ⁸⁾ Function: circuit open in upper float position (NC contact) (H07RN-F 3G1)	5	X	X	X	X	11037756	0,8	
	10	X	X	X	X	11037757	1,4	
	20	X	X	X	X	11037758	2,6	
 E64 F1 leakage sensor Contactor for alarm switchgears AS 0, AS 2, AS 4 or as alarm transmitter for LevelControl Basic 2 Alarm transmission options: High water alert by suspending the sensor in a (pump) sump above the pump start-up point. Warning at a water level of 1 mm in areas with a flooding or leakage risk (e.g. in the cellar or next to the washing machine in the kitchen or bathroom) Dimensions [mm]: 52 × 21 × 20 (H × W × D)	3 m	X	X	X	X	19072366	0,2	
 E70 Horn, 12 V DC, 105 dB, 150 mA, IP54 Suitable for indoor installation and outdoor installation. Protect against moisture.	-	X	X	X	X	01086547	0,1	
 E80 Safety switch STECKMAT Trips in approx. 0.03 seconds, from approx. 0.03 A 230 V / 10 A	-	X	X	X	X	00534217	0,5	
 E90 Rechargeable battery retrofit kit for LevelControl Basic 2, type BC Scope of supply: 2 rechargeable batteries (6 V, 1.3 Ah) and charging unit	-	X	X	X	X	19074194	0,8	

8) Not suitable for LevelControl

Exploded view and list of components

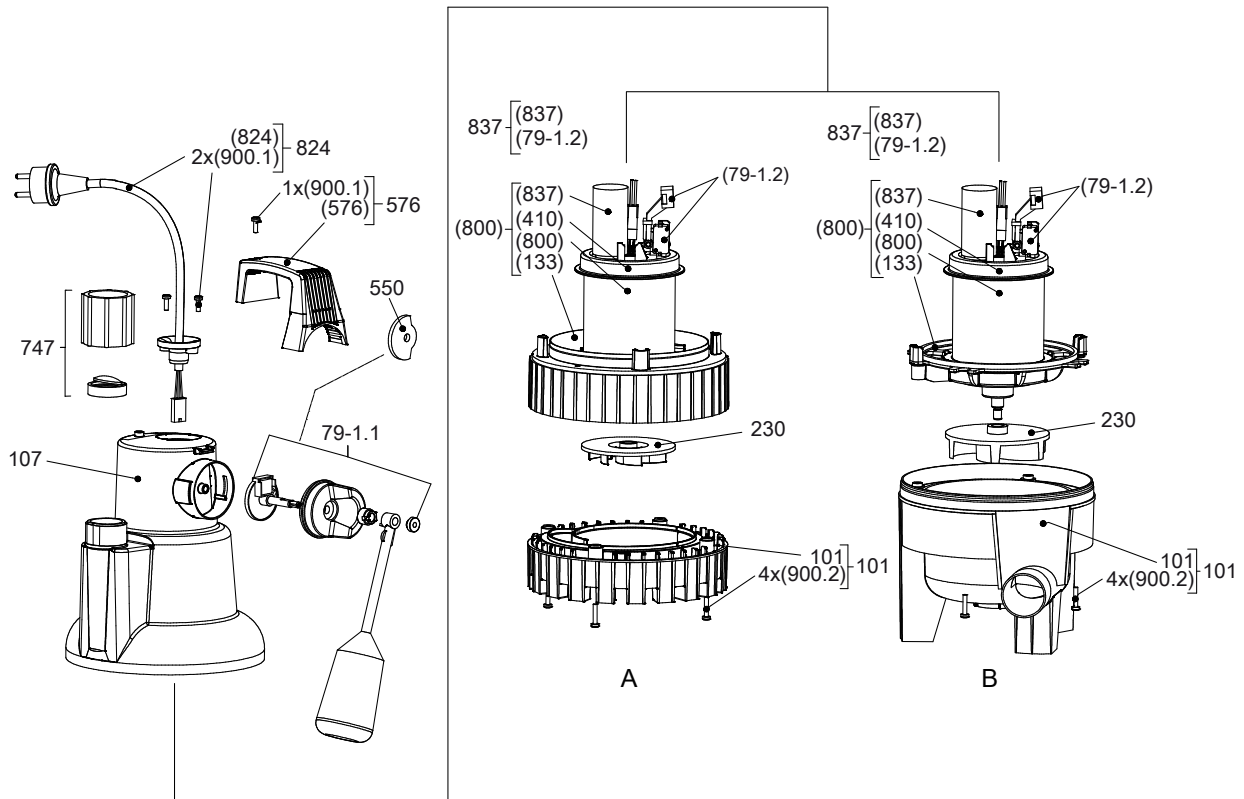

Fig. 8: Exploded view of Ama-Drainer N

List of components

Part No.	Description
101	Pump casing
107	Discharge casing
230	Impeller
550	Locking disc for float
576	Handle
747	Swing check valve and inspection hole
79-1.1	Automatic switch (external)
800	Motor
824	Cable



KSB SE & Co. KGaA
Johann-Klein-Straße 9 • 67227 Frankenthal (Germany)
Tel. +49 6233 86-0
www.ksb.com